

Operating and Maintenance Manual



CR 1-II Hd

0115510

Table of contents

Introduction	4
Safety guidelines	5
Graphic presentation	8
Device description	9
Technical data	10
Activities prior to starting work	12
Starting	14
Compacting	15
Shutting down	16
Maintenance overview	17
Maintenance work	18
Operating fluids and fill levels	20
Troubleshooting	20
Storage	21

Introduction

This operating and maintenance manual is designed to facilitate familiarization with your soil compactor, and to enable you to maintain the compactor and use it for its intended purpose.

When complying with the instructions in the operating and maintenance manual you help avoid hazards, reduce repair and downtime costs, and increase the reliability and service life of your soil compactor.

This operating and maintenance manual must always be available at the implementation site of the soil compactor.

If necessary, you can obtain additional information from your authorized WEBER MT dealer, or you can obtain information from one of the contact addresses on the last page.

You can obtain information on the assembled HONDA gasoline engine and find a spare-part list for it at **www.honda-engines-eu.com**

The valid conformity declaration is enclosed with every machine delivery.

Safety guidelines

General

All safety instructions must be read and complied with, as non-compliance will result in

- Danger to life and limb of the user,
- Impairments to the machine or other property.

In addition to the operating manual, the accident-prevention regulations in the country where the appliance is used must be complied with.

Intended use

The soil compactor should only be used if it is in a technically faultless condition, as intended, in a safety-conscious and hazard-conscious manner, in compliance with the instructions in the operating manual. Malfunctions that impair safety must be eliminated without delay.

The CR 1-II Hd soil compactor is designed exclusively for compacting

- sand,
- gravel,
- crushed rock,
- low-cohesive mixed material,
- concrete paving stone.
- asphalt

Any other use of the soil compactor is considered to be improper use for which the owner shall be exclusively responsible. All liability is rejected if damage occurs due to non-compliance with this provision. This risk is borne solely by the user.

Easily foreseeable misuse

Any use for which the machine is not intended.

Operation

Soil compactors are only permitted to be operated by suitable persons of or above the age of 18. Personnel must be instructed in how to guide the compactor by the owner or by the owner's assigned personnel.

The machine operator must comply with traffic regulations. If instructions that affect safety are given by third parties, then the operator must be authorized to reject these instructions.



Unauthorized persons are forbidden from being in the area of the soil compactor during the compacting process.

Protective equipment

This machine is capable of exceeding the permissible sound level of 80 dB(A). The owner might also face additional dangers when using the machine. Precautionary action must, therefore, be taken.

Protective equipment includes:



Hearing protection



Hard hat



Safety shoes



Protective gloves

Operation

Prior to starting work the owner of the compactor must be familiar with the work environment. The work environment includes obstacles in the work and traffic area, the bearing capacity of the ground, as well as the necessary safeguarding of the construction site in the area adjacent to public traffic; and it includes compliance with traffic regulations.

The soil compactor should only be operated when the protective fixtures are mounted.

The protective fixtures must all be in functional condition.

At least once per shift the compactor must be checked for apparent defects. If there are apparent defects then operation of the compactor must be stopped immediately, and the responsible person must be informed. Prior to restarting, compactor malfunctions that have occurred must be corrected. Always maintain adequate clearance to the edges of pits and embankments.

Do not drive at ninety degrees to slopes to prevent the compactor from tipping over.

After work has been concluded secure the compactor in accordance with statutory regulations, particularly in the area of public traffic surfaces.

Operation under difficult conditions



Never inhale the exhaust gas. It contains carbon monoxide, a colorless and odorless gas that is extremely hazardous, which, if inhaled even briefly, can cause unconsciousness and death.

Therefore, never operate the engines in enclosed areas or in areas that are poorly ventilated (tunnels, caves, covered pits, etc.).

Exercise particular caution when operating the engine in the vicinity of people and livestock.

Maintenance and repair work

Only use **original Weber MT spare parts** to ensure reliable and safe operation for maintenance or repair work.

Hydraulic hose lines must be checked at regular intervals in accordance with standard engineering practice, or they must be replaced at appropriate intervals, even if no signs of safety-relevant defects are present.

Adjusting tasks, maintenance tasks, and inspection tasks must be carried out on schedule as specified in this operating and maintenance manual. These activities should only be executed by instructed personnel.

For repair, service, or inspection work the engine of the compactor must be safeguarded against unintentional starting.

All pressurized lines, particularly hydraulic lines and lines of the injection system of the drive motor must be depressurized before performing maintenance or repair tasks.

For maintenance and repair tasks the compactor must be parked on a level and stable substrate and must be secured from rolling off or tipping over.

Heavy components and assemblies must be secured to and lifted by hoisting machines that can bear their weight when they are replaced. Ensure that no hazard is caused by raising components or assemblies.

Do not position yourself or work under suspended loads.



If lubricating oils and fuel come into contact with skin, they can cause skin cancer. Upon contact with the skin, clean affected skin with suitable cleaning agent without delay.

Inspection

Compactors must be inspected in accordance with the corresponding implementation conditions and operating conditions, as needed; however an inspection to ensure operationally safe status must be performed by an expert at least once a year. The results of the inspection must be recorded in writing and must be stored at least until the next inspection.

Cleaning work

Prior to cleaning the compactor with a high-pressure cleaner, protect all accessible energized switches, cable connections, etc. against water penetration by masking them off.

Cleaning tasks should only be executed in areas that are suitable and have been approved for this purpose (oil separator amongst others).

Disposal

All operating fluids and auxiliary materials must be disposed of in an environmentally compatible manner in accordance with country-specific regulations.

Important information for operating and maintenance personnel is marked by pictograms.



Warning against irritants or materials hazardous to health



Warning against a hazardous place



Warning against a suspended load



Wear ear protection



General regulation



Environmental protection



Hard hat



Safety shoes



Protective gloves

Graphic presentation

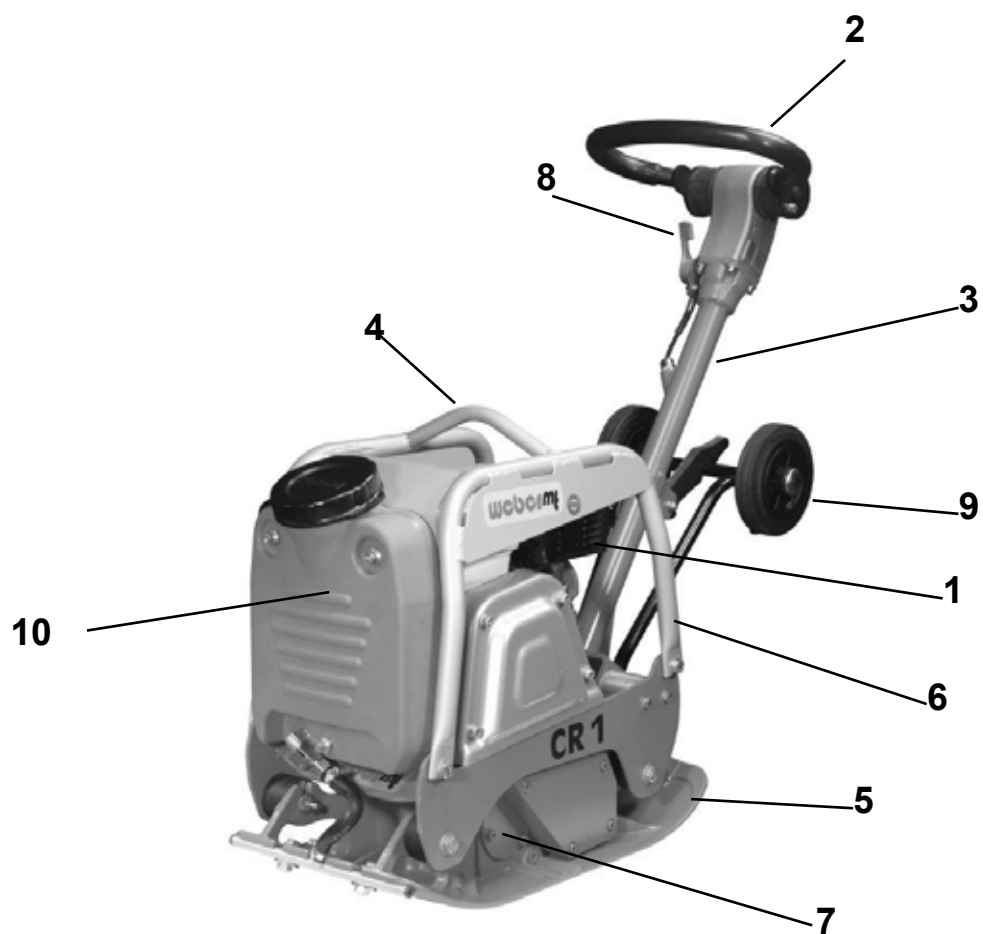

Overall view CR 1-II Hd

- 1 Engine
- 2 Drive lever
- 3 Manual guidance rod
- 4 Lifting ring
- 5 Base plate
- 6 Protective frame
- 7 Exciter
- 8 Gas lever
- 9 Chassis (accessory)
- 10 Water tank (accessory)
- 11 Protective mat (no image; accessory)
- 12 Hearing protection (sticker) 

Device description

The CR 1-II Hd soil compactor is used for road-building and landscaping compaction tasks.

Drive

The unit is powered by an air-cooled Honda gasoline engine.

Force is transferred to the exciter mechanically via a V-belt.

Operation

Start the Honda gasoline engine with the attached reversing starter.

After starting, vibration is switched on via the centrifugal clutch attached to the engine. Use the gas lever to vary the engine speed between idle and full throttle.

Forward and reverse is variably controlled via the drive lever attached to the manual guidance rod.

Technical data

	CR 1-II Hd
Weight	
Operating weight CECE in kg (basic device)	92
Dimensions	
Overall length (in mm)	950
Overall width (in mm)	350
Height with folded manual guidance rod (in mm)	1024
Base plate length (base in mm)	260
Pressure surface (in mm)	350x260
Drive	
Engine manufacturer	Honda
Type	GX 120
Performance at operating speed in accordance with ISO 3046-1 (kW)	2.5
Combustion process	4-stroke gasoline
Operating rpm	3350
Operating speed (ground-dependent in m/min)	20
Incline capacity (ground-dependent in %)	35
Vibration	
System	Two-wave vibrator
Drive concept	Mechanical
Frequency (in Hz)	100
Centrifugal force (in kN)	15

	CR 1-II Hd
Noise emissions in accordance with 2000/14/EC	
Sound pressure level L_{PA} ascertained in accordance with EN 500, in dB (A)	99
Sound power level L_{WA} ascertained in accordance with EN ISO 3744 and EN 500, in dB (A)	108
Vibration values	
Root-mean-square acceleration value for hand-arm vibration ascertained in accordance with EN 500 in m/s^2	2.5
 In accordance with directive 2006/42/EC, complying with the vibration values is the owner's responsibility.	

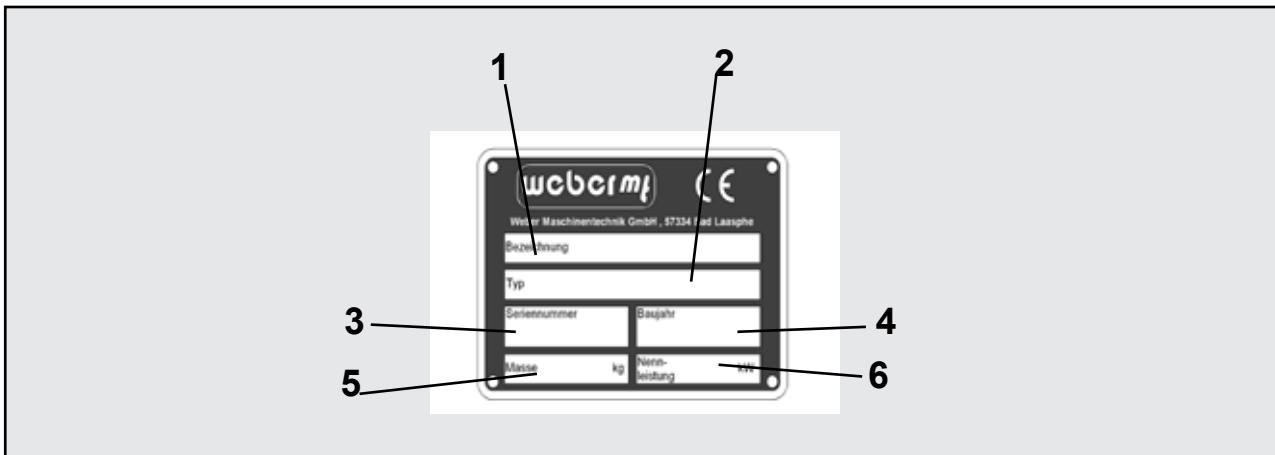

1 Description

.....

2 TYPE

.....

3 Serial number

.....

4 Year of construction

.....

5 Mass

.....

6 Rated power kW

.....

Activities prior to starting work

Transport

 When transporting the soil compactor on a vehicle, secure it with suitable restraints.

Arrest the manual guidance rod (1) with the holder (2).

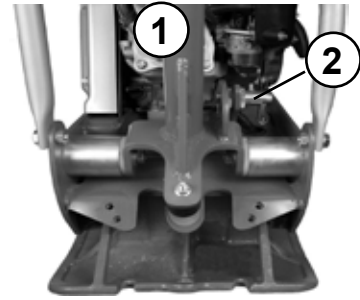

Fit the crane hook into the lifting ring (3) and lift the machine onto the desired means of transport.

 Only use lifting machines with a minimum bearing capacity of 300 kg.

 Do not step under suspended loads.



Transport with chassis

Arrest the manual guidance rod (4) with the holder (5).

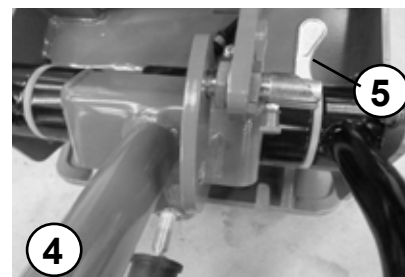

Unlock the holder (6).

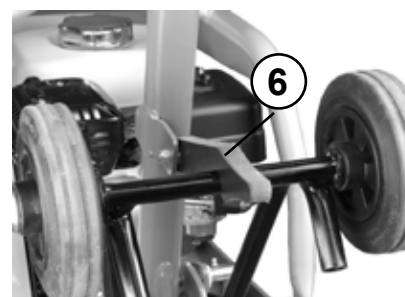

Pivot the chassis (7) under the base plate (8).

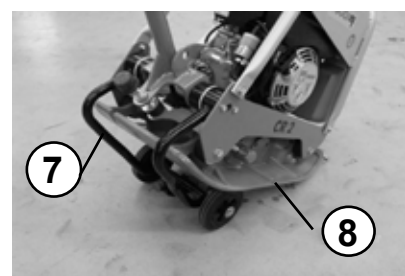

Check the engine oil level

Pull the oil dipstick (1) out of the crankcase.

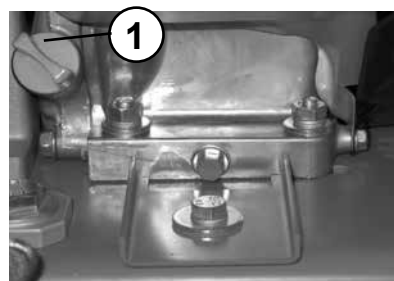
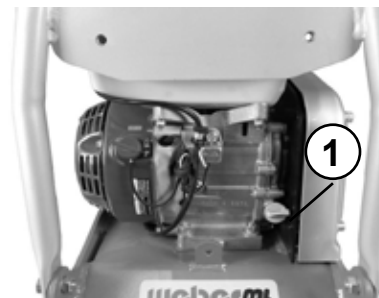

The correct oil level is between the min. and max. marks.



Stop operating the engine immediately when the oil level reaches the min. mark and top off oil until it reaches the max. mark. Risk of engine damage if the oil level drops below the minimum oil level in unfavorable operating conditions.

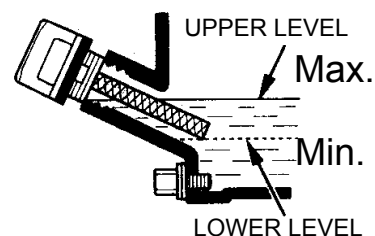

Check the fuel level

Open and remove the gas cap (2), check the level, if necessary top off to the lower edge of the filler neck with clean fuel in accordance with the specification.



For work at the fuel system, have a suitable fire-extinguishing agent at the ready.



Fire, naked light, and smoking is forbidden!



Checking the hydraulic oil level

Check the hydraulic oil level when the machine is at operating temperature. The manual guidance rod must be in the transport position – i.e. folded up. The correct oil level is reached when the oil is in the middle of the view glass.

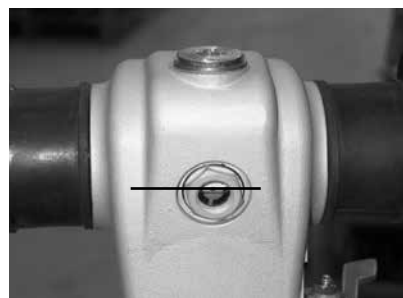

Installing the protective mat

Fasten the protective mat (1) with holder, screws, spring-lock washers and nuts on the base plate front and rear.

 Ensure that the protective mat rests under the base plate.

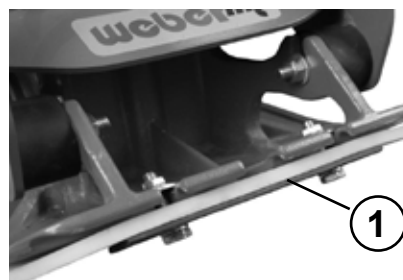

Starting

Bring the gas lever (2) into full-throttle position.

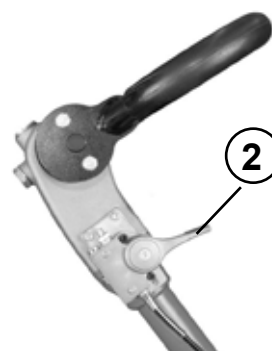

Turn the short-circuit button (3) to the “1” – ON – position.

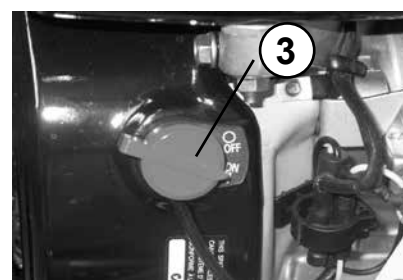

Slide the lever of the fuel cock (4) to the right.
Slide the choke lever (5) to the left (close).

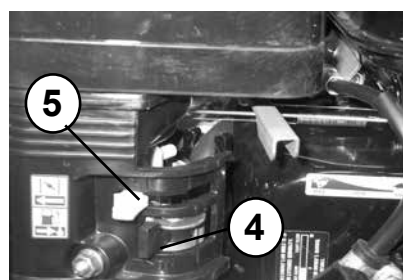

Slowly tighten the handle (6) of the reversing starter (7) until resistance is noticeable.
Allow the handle (6) to glide back into the initial position, and then forcefully and completely pull it through with both hands.

 After the engine has warmed up, slide the choke lever to the right (open).

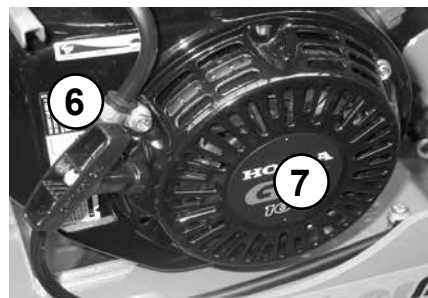

Compacting

Bring the gas lever (1) into full-throttle position.

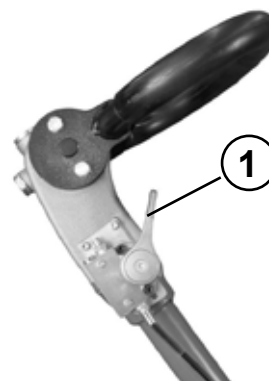

Control drive speed and direction of travel with the handle (2).

 Only run machine within reach of the manual guidance rod.



Shutting down

Bring the gas lever (1) into idle position.

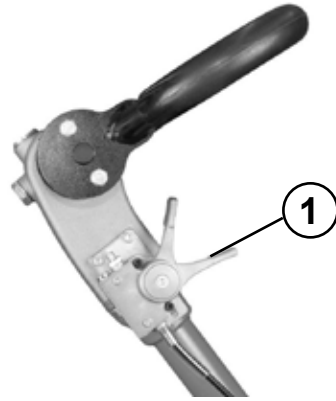

Close the fuel cock (2).

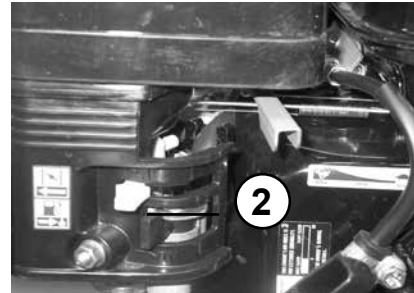





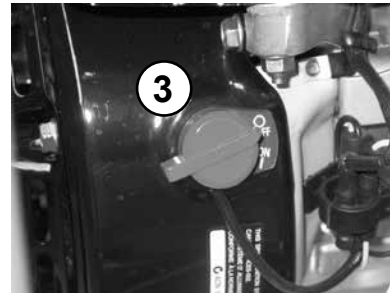

Turn the short-circuit button (3) to the “0” – OFF position.

- ❗ Completely empty the water tank if there might be a frost.
- ❗ During breaks – even if they are short – the machine must be shut down.
- ❗ Parked devices that represent an obstacle must be safeguarded against through conspicuous measures.



Maintenance overview

Maintenance interval	Maintenance point	Maintenance activity
After the first 25 operating hours	Engine	<ul style="list-style-type: none"> – Change the engine oil – Check valve play; adjust if necessary – Re-tighten all accessible threaded connections
Every 8 operating hours/daily	Air filter	<ul style="list-style-type: none"> – Clean air filter insert, check for damage, replace if necessary
Every 50 operating hours/every 6 months	Engine	<ul style="list-style-type: none"> – Change the engine oil – Change the fuel filter – Change the oil filter
Every 150 operating hours/every year	Gearshift Engine Exciter	<ul style="list-style-type: none"> – Change oil – Check valve play; adjust if necessary – Change oil

-  The regulations of the engine manufacturer must be complied with in addition to the above maintenance overview!
-  Work must be carried out using regulation tools, and the operating and maintenance manual must be complied with for all work.
-  All maintenance work: Select collection vessels large enough to prevent oil from spilling onto the ground. Dispose of waste oil in an environmentally friendly manner (regulation on waste oils).
-  Dispose of oils, greases, cloths soaked in oil, and replaced parts with oil on them in an environmentally friendly manner.
-  If lubricating oils and fuel come into contact with skin, they can cause skin cancer. Upon contact with the skin, clean affected skin with suitable cleaning agent without delay.
-  If accessible during maintenance, check the condition and stability of all screws.

Maintenance work

Unscrew the oil dipstick (1).

Remove the oil drain screw (2) and drain oil completely.

 Only drain engine oil when at operating temperature.

Screw the oil drain screw back in and fill the engine with oil as specified.

Use an oil dipstick to check the oil quantity.

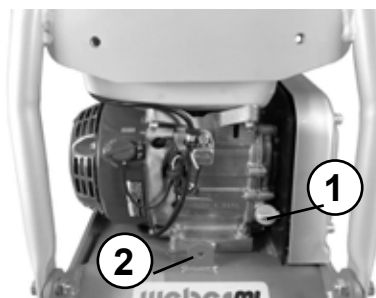

 When working in the area of the engine compartment there is a danger of being burnt!

Clean/change air filter cartridge

Unscrew the air filter cover (3).



Remove the air filter insert (4) from the air filter enclosure.
Clean air filter insert as specified by the engine manufacturer if there is damage or if it is extremely dirty.



Changing the oil in the exciter

Remove the oil drain screw (1) and drain oil.

To fill – tilt the machine slightly and fill with fresh oil through the drain opening in accordance with the fill level table.



Select collection vessels large enough to prevent oil from spilling onto the ground. Dispose of waste oil in an environmentally friendly manner (regulation on waste oils).



Wipe up/off oil slick and oil residue and dispose of fuel-soaked cleaning cloths in an environmentally responsible manner.

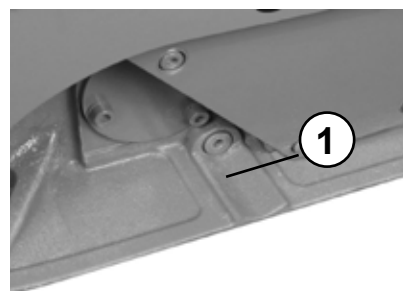

Checking the V-belt

Remove the V-belt guard (2).

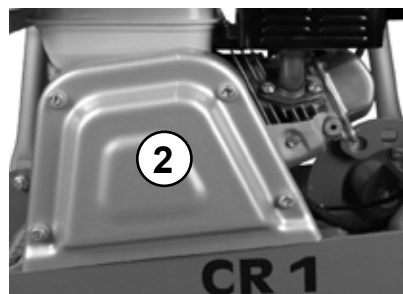

Check the V-belt (3) for cracks, damaged flanks, and wear. If there is excessive wear - replace the V-belt as specified in the repair manual.



Operating fluids and fill levels

Assembly	Operating material		Quantity
	Summer	Winter	CR 1-II Hd
Quality			
Engine Engine oil	SAE 10 W 40 (-10 ~ + 50 °C) API – CD CE-CF-CG or SHPD or CCMC – D4 – D5 – PD2		0.6 l
Fuel tank	Unleaded gasoline		2.0 l
Vibrator	Fully-synthetic transmission fluid API GL-5/GL-4 First filling Fuchs Titan SINTOPOID LS SAE 75W-90		0.5 l
Water tank			7 l
Gearshift	Transmission fluid DEXRON II-D-ATF First filling Fuchs Titan ATF 3000 or equivalent		As necessary

Troubleshooting

Fault	Possible cause	Remedy
Soil compactor does not start	Operating error	Execute start process as prescribed
	Lack of fuel	Check the fuel level
	Fuel filter fouled	Change the fuel filter
	Air filter fouled	Clean/change air filter cartridge
No vibration / no forward motion or insufficient forward motion	Vibrator V-belt defective	Change vibrator V-belt

Actions to be taken before long-term storage (longer than 1 month)

Entire soil compactor	<ul style="list-style-type: none">– Clean thoroughly– Check for leaks– If there are leaks, correct defects
Fuel tank	<ul style="list-style-type: none">– Empty fuel and fill with clean fuel up to the lower edge of filler neck
Engine	<ul style="list-style-type: none">– Check oil level, if necessary fill to upper oil-level mark– Check air filter, clean, replace if necessary– Check fuel filter, change if necessary
All bare parts / gas lever / accelerator control cables / fastening bolts	<ul style="list-style-type: none">– Oil / grease



If the machine is to be stored for longer than six months, then contact the Weber service organization to discuss additional measures.



facebook.com/WeberMT



youtube.com/MyWeberMT



Weber Maschinentechnik GmbH

Im Boden 5–8, 10 · 57334 Bad Laasphe · Germany

Tlf. +49 2754 398 0 · Faks +49 2754 398 101

info@webermt.de · www.webermt.de