

Operating and Maintenance Manual



CR 5 HD

Honda GX 270



Weber Maschinenteknik GmbH

Im Boden 5 - 8, 10

57334 Bad Laasphe-Rückershausen / Germany

Telephone +49 (0) 27 54 / 398-0

Fax +49 (0) 27 54 / 398-101

E-Mail: info@webermt.de

Web: www.webermt.de

Table of contents

Introduction	4
Safety guidelines	5
Graphic presentation	8
Device description	9
Technical data	10
Activities prior to starting work	12
Starting	13
Compacting	14
Shutting down	15
Maintenance overview	16
Maintenance work	17
Operating fluids and fill levels	19
Troubleshooting	19
Measures to be taken if stored for long periods	20
Contact addresses	23

Introduction

This operating and maintenance manual is designed to facilitate familiarization with your soil compactor, and enable you to maintain the compactor and use it in accordance with the proper application possibilities.

When complying with the instructions in the operating and maintenance manual you help avoid hazards, reduce repair and downtime costs, and increase the reliability and service life of your compactor.

This operating and maintenance manual must always be available at the implementation site of the soil compactor.

If needed you can obtain additional information from your authorized WEBER dealer, or you can obtain information from one of the contact addresses on the last page.

You can obtain information on the assembled Honda petrol engine and find a spare-part list for it at **www.honda-engines-eu.com**

The valid conformity declaration is enclosed with every machine delivery.

Safety guidelines

General

All safety instructions must be read and complied with, non-compliance results in

- Danger to life and limb of the user
- Impairments to the machine or other property.

In addition to the operating manual the binding accident prevention guidelines in the country where the compactor is used must be complied with.

Proper use

The soil compactor should only be used in technically faultless condition, as intended, in a safety-conscious and hazard-conscious manner, in compliance with the instructions in the operating manual. Malfunctions that impair safety must be eliminated without delay.

The CR 5 soil compactor is designed exclusively for compacting

- Sand
- Gravel
- Crushed rock
- Semi-cohesive mixed material
- Concrete paving stone

Any other use of the soil compactor is considered to be improper use for which the owner shall be exclusively responsible. All liability is rejected if damage occurs due to non-compliance with this provision. This risk is borne solely by the user.

Easily foreseeable misuse

Any use for which the machine is not intended.

Driving

Soil compactors should only be driven by suitable personnel at least 18 years of age, Drivers must be instructed in how to guide the compactor by the owner or by owner's assigned personnel.

The machine operator must comply with traffic regulations. If instructions that affect safety are given by third persons, then the operator must be authorized to reject these instructions.



Unauthorized persons are forbidden from being in the area of the soil compactor during the compacting process.

Protective equipment

This machine is capable of exceeding the permissible sound level of 80 dB(A). The owner might also face additional dangers when using the machine. Precautionary action must, therefore, be taken.

Protective equipment includes:



Ear protection



Hard hat



Safety shoes



Protective gloves

Operation

Prior to starting work the owner of the compactor must be familiar with the work environment. The work environment includes obstacles in the work and traffic area, the bearing capacity of the ground, as well as the necessary safeguarding of the construction site in the area adjacent to public traffic; and it includes compliance with traffic regulations.

The soil compactor should only be operated when the protective fixtures are mounted. The protective fixtures must all be in functional condition.

At least once per shift the compactor must be checked for apparent defects. If there are apparent defects then operation of the compactor must be stopped immediately and the responsible person must be informed. Prior to restarting, compactor malfunctions that have occurred must be corrected.

Operation under difficult conditions

 Never inhale the exhaust gas; it contains carbon monoxide, a colorless and odorless gas that is extremely hazardous, which if inhaled even briefly can cause unconsciousness and death.

Never operate the engines in enclosed areas or in areas that are poorly ventilated (tunnels, caves, etc.) Exercise particular caution when operating the engine in the vicinity of people and livestock.

Prior to maintenance and repair work

Only use **original Weber spare parts** to ensure reliable and safe operation for maintenance or repair work.

Hydraulic hose lines must be checked at regular intervals in accordance with standard engineering practice, or they must be replaced at appropriate intervals, even if no signs of safety-relevant defects are present.

Adjusting tasks, maintenance tasks, and inspection tasks must be executed on schedule as specified in this operating and maintenance manual. These activities should only be executed by instructed personnel.

For repair, maintenance, or inspection work the engine of the compactor must be safeguarded against unintentional starting.

All pressurized lines, particularly hydraulic lines and lines of the injection system of the drive motor must be depressurized before performing maintenance or repair tasks.

For maintenance and repair tasks the compactor must be parked on a level and stable substrate and must be secured from rolling off or tipping over.

Heavy components and subassemblies must be secured on hoisting machines with adequate bearing capacity when they are replaced. Ensure that no hazard exists related to the raised components or subassemblies.

Do not position yourself or work under suspended loads.

 If lubricating oils and fuel come into contact with skin, they can cause skin cancer. Upon contact with the skin, clean affected skin with suitable cleaning agent without delay.

Inspection

Compactors must be inspected in accordance with appropriate implementation conditions and operating conditions, as needed; however an inspection to ensure operationally safe status must be performed by an expert at least once a year. The results of the inspection must be recorded in writing and must be stored until the next inspection.

Cleaning work

Prior to cleaning the compactor with a high-pressure cleaner, protect all accessible energized switches, cable connections, etc. against water penetration by masking them off.

Cleaning tasks should only be executed in areas that suitable and approved for this purpose (oil separator).

Disposal

All operating fluids and auxiliary materials must be disposed of in an environmentally-compatible manner, in accordance with country-specific regulations.

Important information for operating and maintenance personnel is marked by pictograms.



Warning against irritants or materials hazardous to health



Warning against a hazardous place



Warning against a suspended load



Wear ear protection



General regulation



Environmental protection



Hard hat



Safety shoes



Protective gloves

Graphic presentation

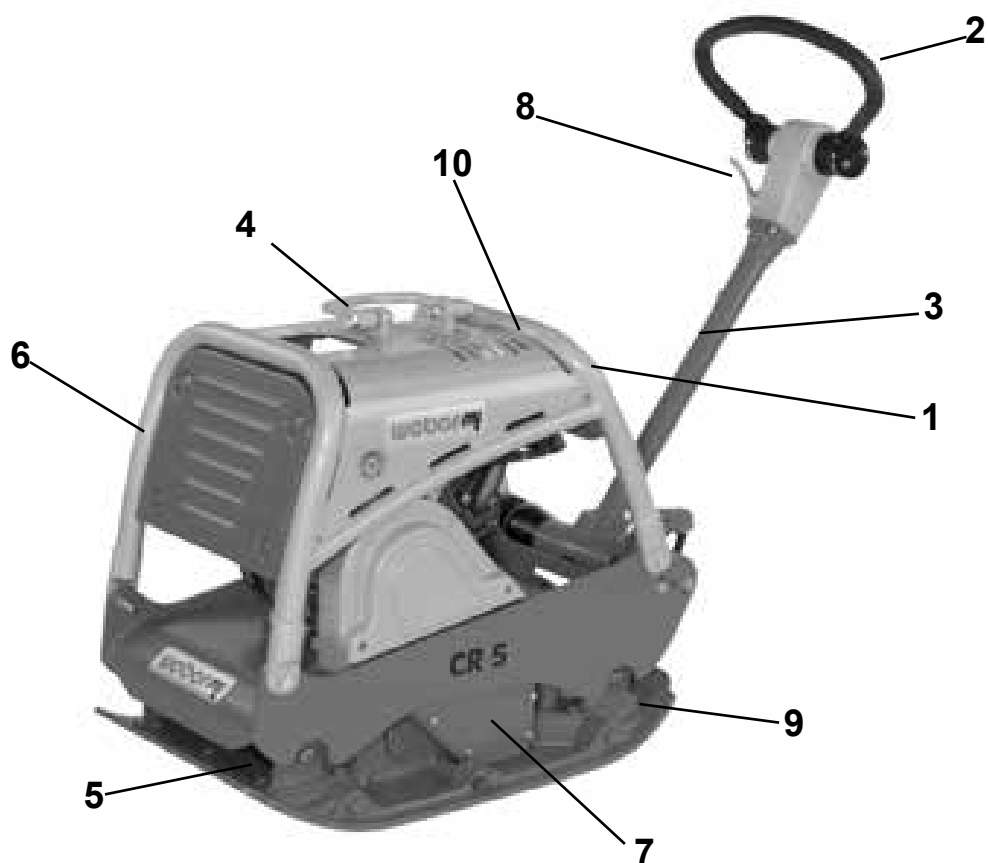

Overall view CR 5 HD

- 1 Engine
- 2 Drive lever
- 3 Hand guidance rod
- 4 Lifting ring
- 5 Base plate
- 6 Protective frame
- 7 Exciter
- 8 Gas lever
- 9 Attachment plates
- 10 Wear ear protection (Sticke) 

Device description

The CR 5 HD compactor is used for road-building and landscaping compaction tasks.

Drive

The compactor is propelled by an air-cooled Honda gasoline engine.

Force is transferred to the exciter mechanically via a V-belt.

Operation

Start the Honda gasoline engine with the attached reversing starter.

After starting, vibration is switched on via the centrifugal clutch attached to the engine. Use the gas lever to vary the engine speed between idle and full throttle.

Forward and reverse id variably controlled via the handle attached to the hand guidance rod.

Technical data

	CR 5 HD
Weight	
Operating weight CECE in kg (basic device)	273
Dimensions	
Overall length in (in mm)	1520
Overall width/with attachment plates (in mm)	550/700
Height with folded manual guidance rod (in mm)	1070
Base plate length (base in mm)	250
Pressure surface (in mm)	250x550
Drive	
Engine manufacturer	Honda
Type	GX 270
Performance at operating speed in accordance with ISO 3046-1 (kW)	5,1
Combustion process	4-stroke gasoline
Speed	3000
Operating speed (m/min)	20
Incline capacity (ground-dependent in %)	35
Area capacity/with attachment plates (in m ² /h)	660/840
Vibratory	
system	Two-wave vibrator
Drive concept	Mechanical
Frequency (in Hz)	75
Centrifugal force (in kN)	42

	CR 5 HD
Noise emissions in accordance with 2000/14/EC	
Sound pressure level L_{PA} ascertained in accordance with EN 500, in dB (A)	98
Sound power level L_{PA} ascertained in accordance with EN ISO 3744 and EN 500, in dB (A)	108
Vibration values	
Root-mean-square acceleration value for hand-arm vibration ascertained in accordance with EN 500 in m/s ²	3,3
 In accordance with directive 2006/42/EC, complying with the vibration values is the owner's responsibility.	

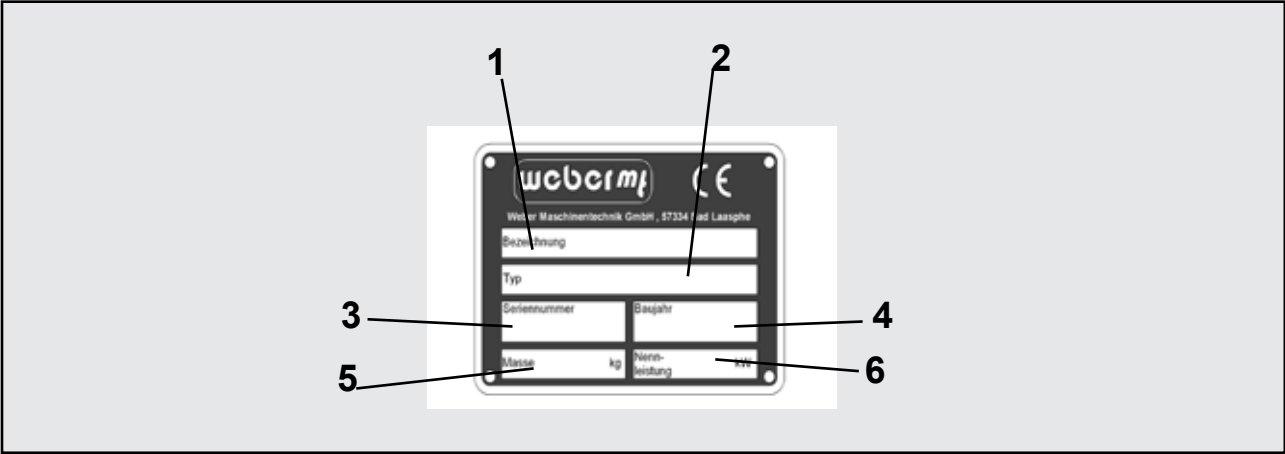

<p>1 Description</p> <p>.....</p>	<p>2 TYPE</p> <p>.....</p>
<p>3 Serial-Number</p> <p>.....</p>	<p>4 Year of construction</p> <p>.....</p>
<p>5 Mass</p>	<p>6 Rated power KW</p>

Activities prior to starting work

Transport

Arrest the hand guidance rod (1) with the spring bolt (2).

 When transporting the soil compactor on a vehicle, secure it with suitable restraints.

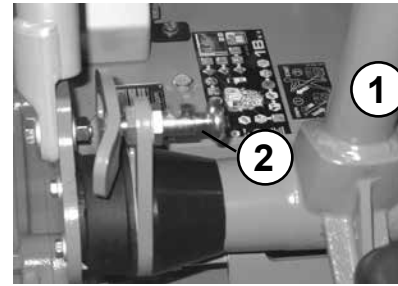

Fit the crane hook into the hinged lifting ring (1) and lift the machine onto the desired means of transport.

 Only use lifting machines with a minimum bearing capacity of 300 kg.

 Do not step under suspended loads.



Adjusting the hand guidance rod

Adjust the desired work height of the hand guidance rod with the set screw (1).

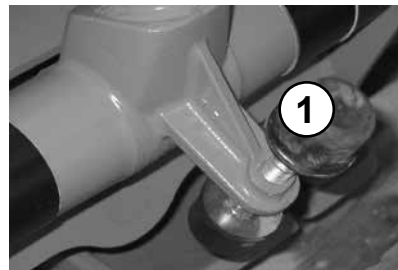

Checking the engine oil level

Unscrew and remove the oil dip stick from the crankcase.



The correct oil level is between the min. and max. marks.

 Insert the oil dip stick in the oil filler neck, however do not screw it in.

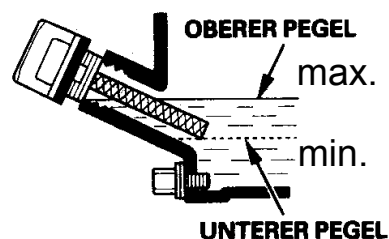

Check the fuel level

Open the gas cap, check the fill level, if necessary top off with clean fuel in accordance with the specification to the lower edge of filler neck.

 For work at the fuel system, have a suitable fire-extinguishing agent at the ready.

 Fire, naked light, and smoking is forbidden!



Checking the hydraulic fluid level

Check the hydraulic oil level when the machine is at operating temperature. The correct oil level is reached when the oil is in the middle of the view glass.

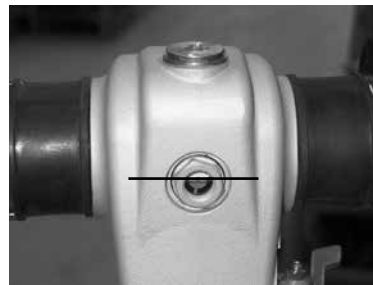

Mounting the attachment plates

Tighten the screws (1) of the attachment plates (2) with a torque of 320 NM.

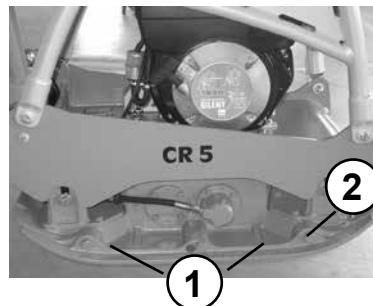

Mounting the Poly pad

Fasten the Poly pad with holder, screws, spring-lock washers and nuts on the base plate front and rear.

 Ensure that the Poly pad rests under the base plate.





Starting

Turn the short-circuit button to the „ON position.

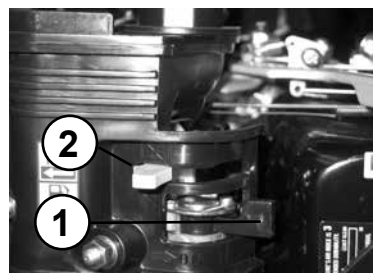

Slide the lever of the fuel cock (1) to the right.
Slide the choke lever (2) to the left (close).



 After the engine has warmed up, slide the choke lever (2) to the right (open).

Bring the gas lever into full-throttle position.

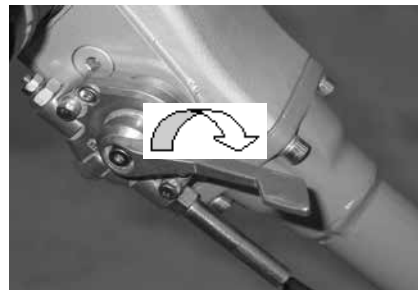

Slowly tighten the handle (1) of the reversing starter (2) until resistance is noticeable.

Allow the handle (1) to slide back into the initial position, and then forcefully and completely pull it through with both hands.

Allow the engine warm up for a few minutes.

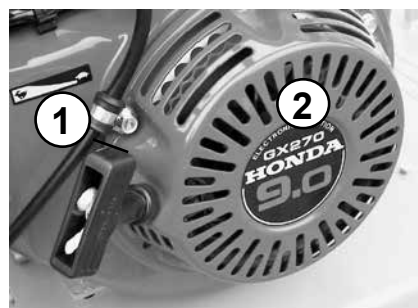

Compacting

Bring the gas lever (1) into full-throttle position.

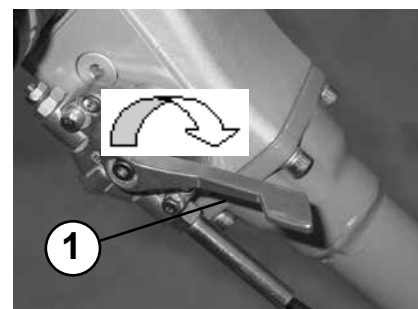

Control drive speed and direction of travel with the handle (1).



Only run machine within reach of the manual guidance rod.



Shutdown

Bring the gas lever (1) into idle position.

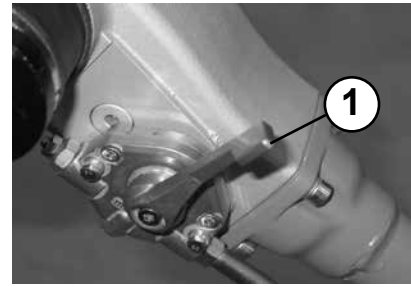

Push the fuel cock (1) to the right (close).

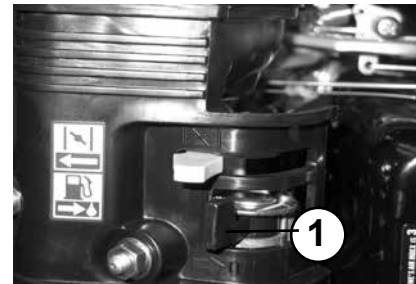

Turn the short-circuit button to the „0“ - OFF position.







⚠ During breaks—even if they are short—the machine must be shut down.

⚠ Parked devices that represent an obstacle must be safeguarded against conspicuously.



Maintenance overview

Maintenance interval	Maintenance point	Maintenance activity
After the first 10 operating hours	Engine	- Change engine oil - Re-tighten all accessible threaded connections
Every 8 operating hours/daily	Air filter	Clean air filter insert, - check for damage, replace if necessary
Every 50 operating hours/every 6 months	Engine	- Change engine oil - Change the fuel filter - Change oil filter
Every 150 operating hours/every year	Transmission Exciter	- Change oil - Change oil

-  In addition to the aforementioned maintenance work, the engine manufacturer's regulations must be complied with.
-  Work must be carried out using regulation tools and the operating and maintenance manual must be complied with for all work.
-  All maintenance work: select a collection vessel that is large enough to prevent oil from spilling onto the ground. Dispose of waste oil in an environmentally friendly manner (regulation on waste oils).
-  Dispose of oils, oil-soaked cloths, and parts replaced and smeared with oil in an environmentally friendly manner.
-  If lubricating oils and fuel come into contact with skin, they can cause skin cancer. Upon contact with the skin, clean affected skin with suitable cleaning agent without delay.
-  If accessible during maintenance, check the condition and stability of all screws.

Maintenance work

Changing the engine oil

Remove oil dip stick.

 Only drain engine oil when at operating temperature.



Screw the oil drain pipe (1) onto the engine drain valve and drain off the oil.

After emptying completely, unscrew the oil drain pipe from the drain valve and fill with oil in accordance with the specification.

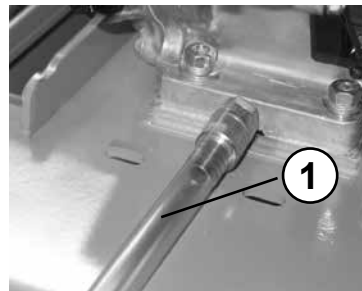

 When working in the area of the engine compartment there is danger of burn injury!

 Danger of scalding due to hot oil.

Clean/change air filter cartridge

Unscrew the air filter cover.

 If lubricating oils and fuel come into contact with skin, they can cause skin cancer. Upon contact with the skin, clean affected skin with suitable cleaning agent without delay.



Remove the air filter insert from the air filter enclosure. Clean the air filter insert in accordance with the guidelines provided by the engine manufacturer, or replace if there is extreme fouling.



 Dispose of oils, oil-soaked cloths, and parts replaced and smeared with oil in an environmentally friendly manner.

Changing the oil in the exciter

Remove the oil drain plug (1) and drain oil.

To fill - tilt the machine slightly and fill with fresh oil through the drain opening in accordance with the fill level table.



All maintenance work: select a collection vessel that is large enough to prevent oil from spilling onto the ground. Dispose of waste oil in an environmentally friendly manner (regulation on waste oils).



Dispose of oils, oil-soaked cloths, and parts replaced and smeared with oil in an environmentally friendly manner.

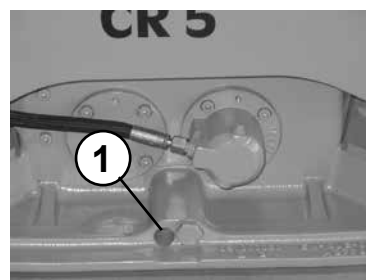

Checking the V-belt

Remove the V-belt guard (1).

Check the V-belt (1) for cracks, damaged flanks, and wear.

If there is excessive wear - replace the V-belt as specified in the repair manual.

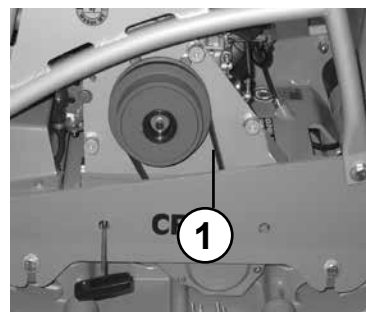
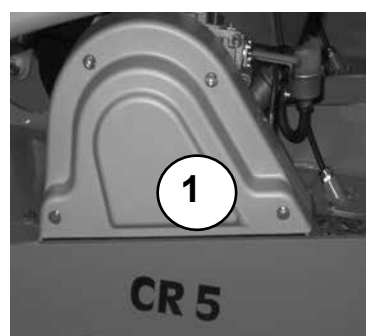

Operating fluids and fill levels

Subassembly	Operating material		Quantity
	Summer	Winter	CR 5 HD
Engine Engine oil	SAE 10 W 40 (-10 ~ + 50 °C) API - CD CE-CF-CG or SHPD or CCMC - D4 - D5 - PD2		1,1 l
Fuel tank	Regular unleaded gasoline		5,3 l
Vibrator	Fully-synthetic transmission fluid API GL-5/GL-4 First filling Fuchs Titan SINTOPOID LS SAE 75W-90		0.75 l
Transmission	Transmission fluid DEXRON II-D-ATF First filling Fuchs Titan ATF 3000 or equivalent		As necessary

Troubleshooting

Fault	Possible cause	Remedy
Soil compactor does not start	Operating error Lack of fuel Fuel filter fouled Air filter fouled	Execute start process as prescribed Check the fuel level Change the fuel filter Clean/change air filter cartridge
No vibration / no forward motion or insufficient forward motion	Vibrator V-belt defective	Change vibrator V-belt
Soil compactor does not switch	Hydraulic oil level in the hand guidance rod is not correct	Check oil level Correct oil level

Measures to be taken if stored for long periods (longer than one month)

Entire soil compactor	<ul style="list-style-type: none"> - Clean thoroughly - Check watertight - If there are leaks, correct defect
Fuel tank	<ul style="list-style-type: none"> - Empty fuel and fill with clean fuel up to the lower edge of filler neck
Engine	<ul style="list-style-type: none"> - Check oil level, if necessary fill to upper oil-level mark - Check air filter, clean, replace if necessary - Check fuel filter, change if necessary
All bare parts/accelerator/accelerator control cable/fastening bolts	<ul style="list-style-type: none"> - Oil/grease
Starter battery (if there is one)	<ul style="list-style-type: none"> - Remove battery - Check acid level; if it is too low, fill with distilled water up to max. mark of the battery - Store above freezing in a storage room - Attach permanent charger

 If the machine is to be stored for longer than six months, then contact the Weber service organization to discuss additional measures.



Weber Maschinentechnik GmbH

For problems, questions and further information refer to one of the following addresses:

in Germany	WEBER Maschinentechnik GmbH Im Boden 5 – 8, 10 57329 Bad Laasphe - Rückershausen	Telefon Telefax E-Mail	+ 49 (0) 2754 - 398-0 + 49 (0) 2754 - 398101-switchboard + 49 (0) 2754 - 398102- spare parts- directlinie g.voelkel@webermt.de
in France	WEBER Technologie SARL 14' rue d' Arsonval 69680 Chassieu	Telefon Telefax E-Mail	+ 33 (0) 472 -791020 + 33 (0) 472 -791021 france@webermt.com
in Poland	WEBER Maschinentechnik Sp. zo.o. Ul. Jezioraki 86 02-863 Warszawa	Telefon Telefax E-Mail	+ 48 (0) 22 - 739 70 - 80 + 48 (0) 22 - 739 70 - 81 + 48 (0) 22 - 739 70 – 82 info@webermt.com.pl
In Tschechien	WEBER MT s.r.o. V Piskovne 2054 278 01 Kralupy nad Vitavou	Telefon E-Mail	+ 42 (0) 776 222 216 + 42 (0) 776 222 261 info@webermt.cz
in USA and Canada	WEBER MT 4717 Broadmoor Ave. SE Suite B Grand Rapids, MI 49512	Telefon Telefax E-Mail	+ 1(207) - 947 - 4990 + 1(207) - 947 – 5452 sales@webermt.us service@webermt.us

> Vibration plates

> Vibrating tampers

> Vibration rollers

> Joint cutters

> Internal vibrators and converters

> Rollers



Weber MASCHINENTECHNIK GmbH

Im Boden

57334 Bad Laasphe - Rückershausen

Telephone + 49 27 54 / 398 0 - Fax +49 27 54 / 398 101